







META Waschtisch-Einhandbatterie ohne Ablaufgarnitur - Champagne gebürstet
(22kt Gold)

META

33 525 660



- Ausladung 105 mm
- starrer Auslauf
- runder luftangereicherter Strahl
- Armaturenhöhe 138 mm
- Höhe bis Luftsprudler 57 mm
- Bohrungsdurchmesser 35 mm
- Rosette Ø 50 mm wahlweise
- 2x Druckschlauch M 8 x 1 eingeschraubt, dichtheitsgeprüft
- Durchfluss max. 5,7 l/min
- bleifrei
- Dieses Produkt leistet einen Beitrag zur Erfüllung der Vorgaben von nachhaltigen Gebäudezertifizierungen, z.B. LEED®, BREEAM®, DGNB

| | | |
|---|---------------------------------|---------------|
|  | Champagne gebürstet (22kt Gold) | 33 525 660-46 |
|  | Chrom | 33 525 660-00 |
|  | Platin gebürstet | 33 525 660-06 |
|  | Platin | 33 525 660-08 |
|  | Dark Chrome | 33 525 660-19 |
|  | Light Gold | 33 525 660-26 |
|  | Light Gold gebürstet | 33 525 660-27 |
|  | Messing gebürstet (23kt Gold) | 33 525 660-28 |
|  | Rot | 33 525 660-29 |
|  | Orange | 33 525 660-30 |
|  | Dunkelgrün | 33 525 660-31 |
|  | Schwarz matt | 33 525 660-33 |
|  | Bronze gebürstet | 33 525 660-42 |
|  | Champagne (22kt Gold) | 33 525 660-47 |
|  | Chrom gebürstet | 33 525 660-93 |
|  | Dark Platinum gebürstet | 33 525 660-99 |

33 525 660
mm [inches]

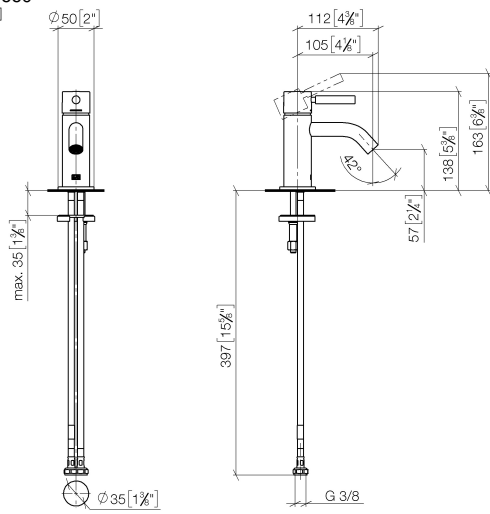

Durchflussdiagramm



33 525 660
Ersatzteile für die
anderen
Oberflächenvarianten
finden Sie hier:
Chrom

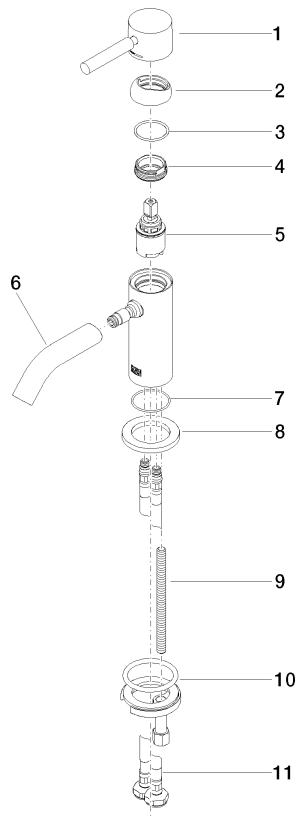

Ersatzteilstückliste

| Nr. | Artikelnummer | Benennung | Verbaumenge | Lieferzeit |
|-----|--------------------|------------------|-------------|------------|
| 1 | 90 20 66 009 00-46 | Griff | 1 | 30 |
| 2 | 09 28 30 043-46 | Haube | 1 | 60 |
| 3 | 09 14 10 120 90 | Dichtung | 1 | 2 |
| 4 | 09 24 04 266 90 | Mutter | 1 | 2 |
| 5 | 90 15 05 044 00 90 | Kartusche | 1 | 2 |
| 6 | 90 11 06 212 00-46 | Auslauf | 1 | 30 |
| 7 | 09 14 10 202 90 | Dichtung | 1 | 2 |
| 8 | 09 27 66 006-46 | Rosette | 1 | 60 |
| 9 | 09 31 11 012 90 | Stift | 1 | 2 |
| 10 | 04 30 11 038 00 90 | Befestigungssatz | 1 | 2 |
| 11 | 04 30 04 100 00 90 | Schlauch | 2 | 2 |